

Numerical modeling of various ice formations in north seas and their influence on seismic replies

Authors:

Stognii P.V.

Petrov D.I.

Petrov I.B.

Plan

- Research of seismic replies in north seas with ice cover and oil slice (without oil slice)-different models
- Research of seismic replies in north seas with icebergs and oil slice (without oil slice)-different models
- Research of seismic replies in north seas with toros and oil slice (without oil slice)-different models

General parameters of models

- Space step: 1 m
- Time step: 10^{-4} sec.
- Number of steps in time: 60000
- Area of integration: 4000 m^2
- On all sides of area calculated - unreflecting boundary conditions
- Source of impulse-on the surface of integrated area in the centre
- Receivers of impulse-on the bottom of the sea

Models with ice cover

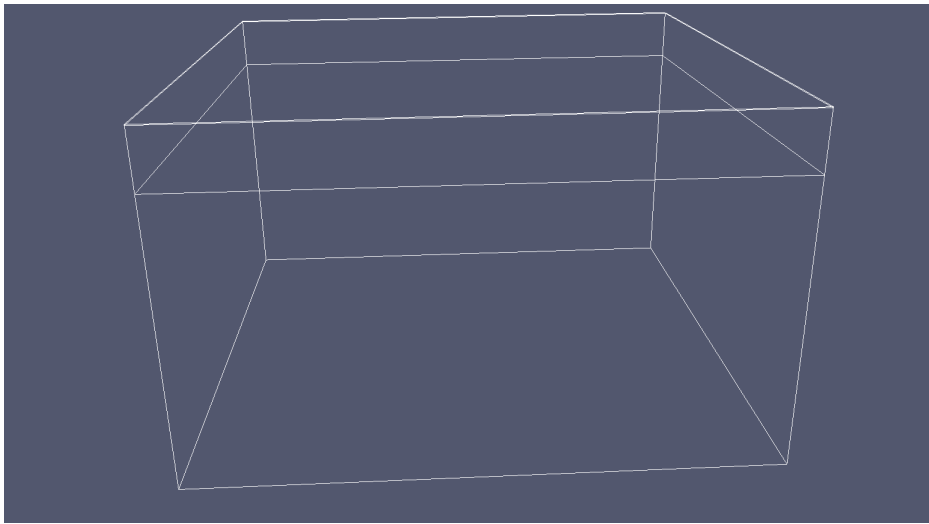

Model without oil

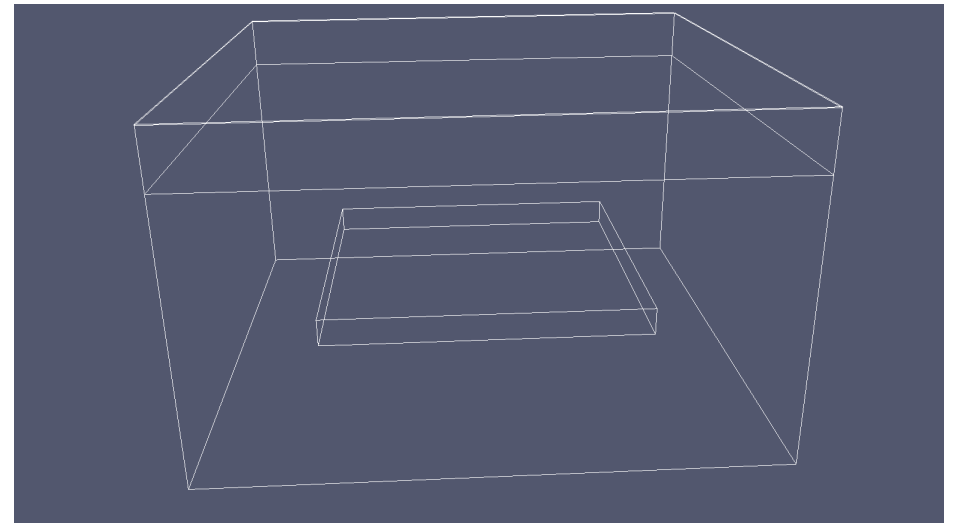

Model with oil

Wave patterns for models with ice cover

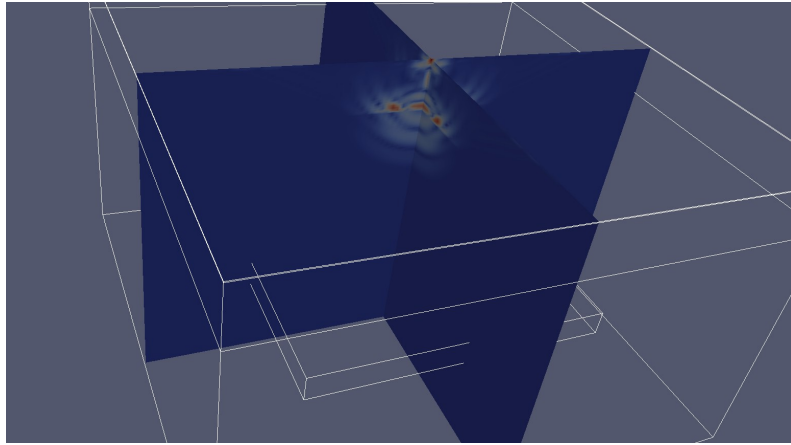

Time 0.18 sec.

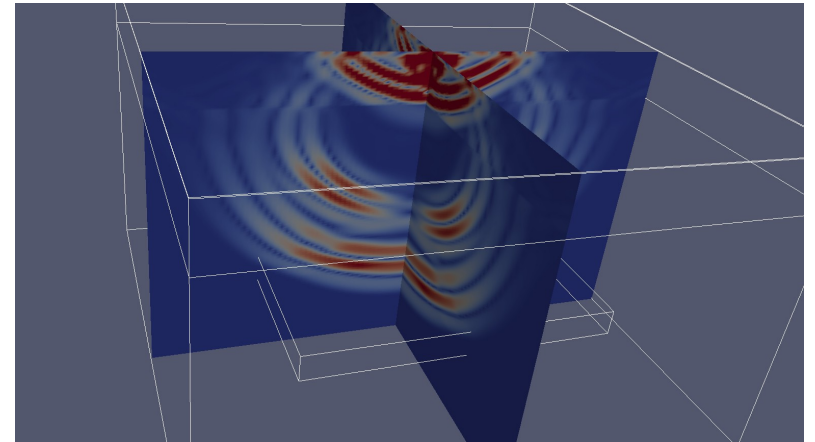

Time 0.38 sec.

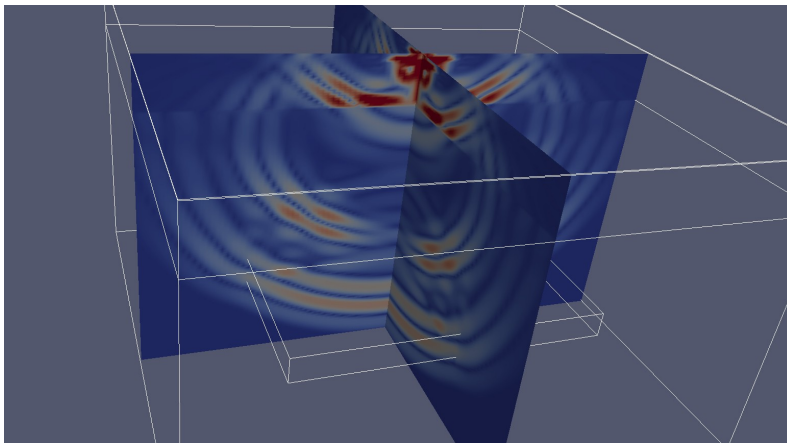

Time 0.44 sec.

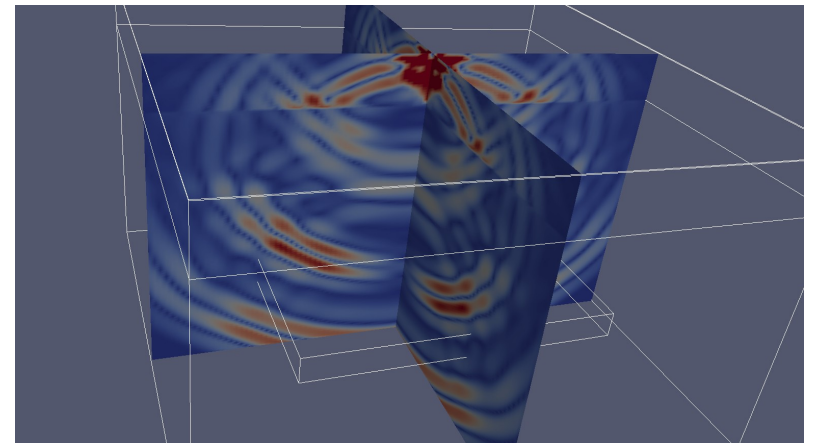

Time 0.52 sec.

Seismograms for models with ice cover

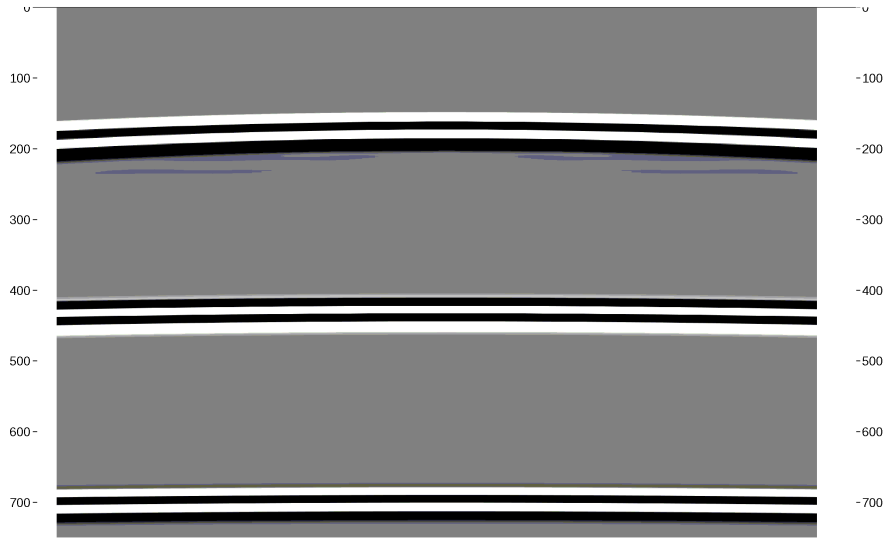

Model with oil



Model without oil

Models with icebergs

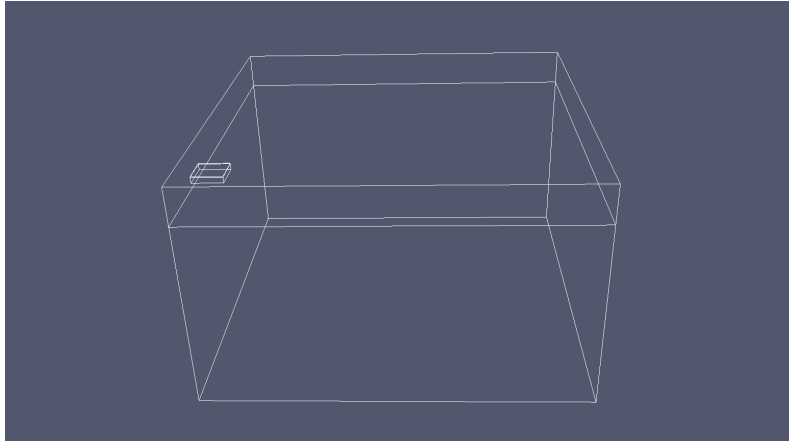

Model with 1 iceberg without oil

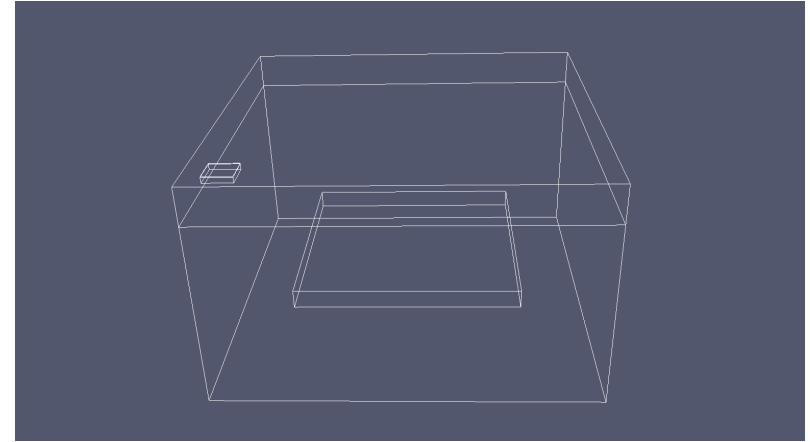

Model with 1 iceberg with oil

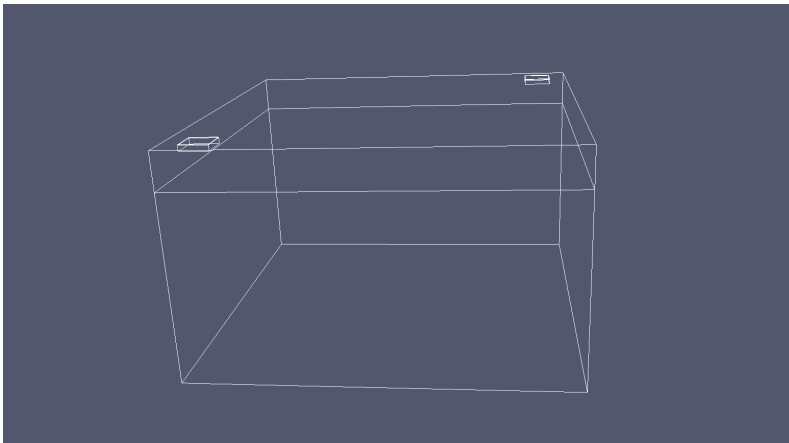

Model with 2 icebergs without oil

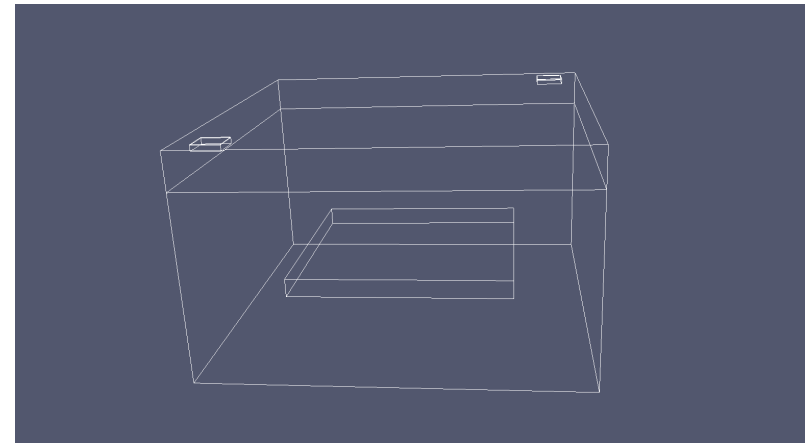

Model with 2 icebergs with oil

Wave patterns for models with 1 iceberg

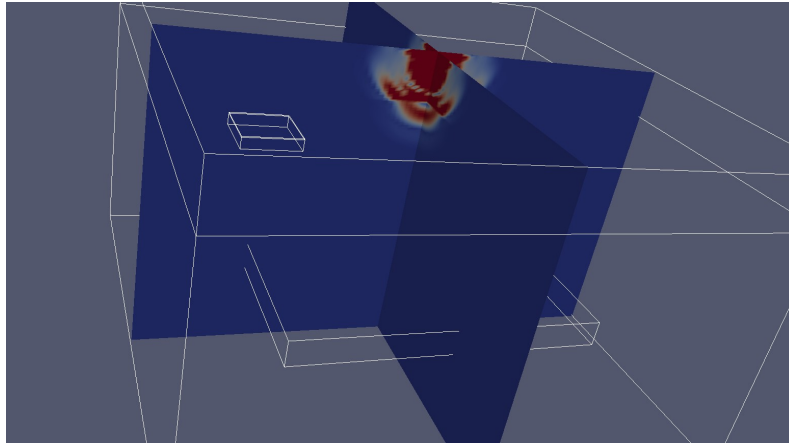

Time 0.15 sec.

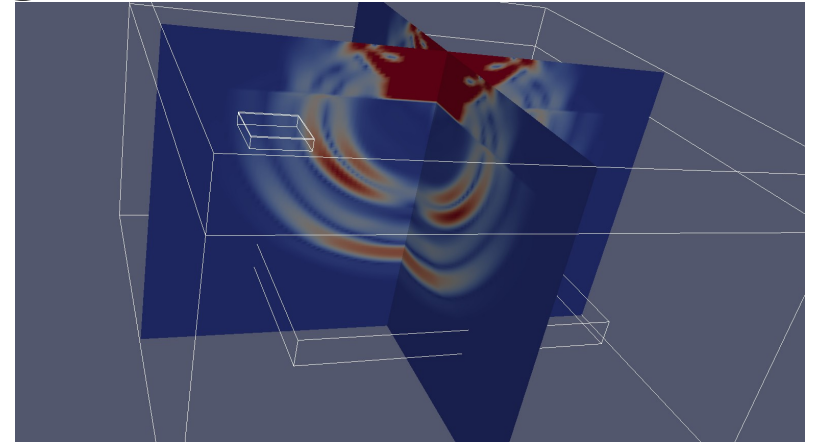

Time 0.35 sec.

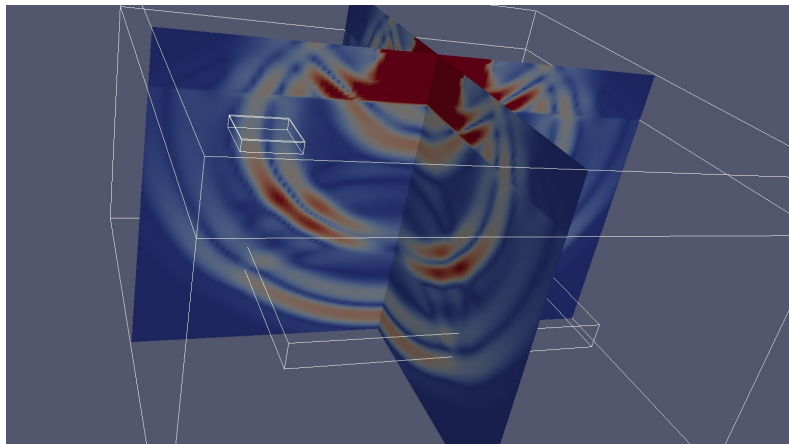

Time 0.45 sec.

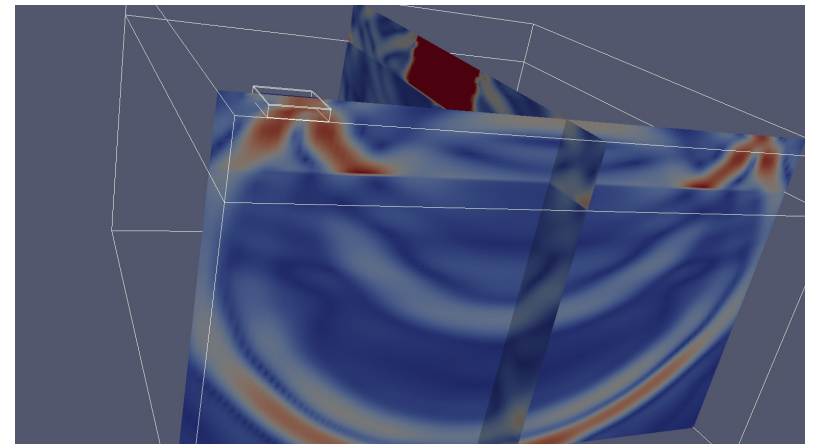

Time 0.8 sec.

Wave patterns for models with 2 icebergs

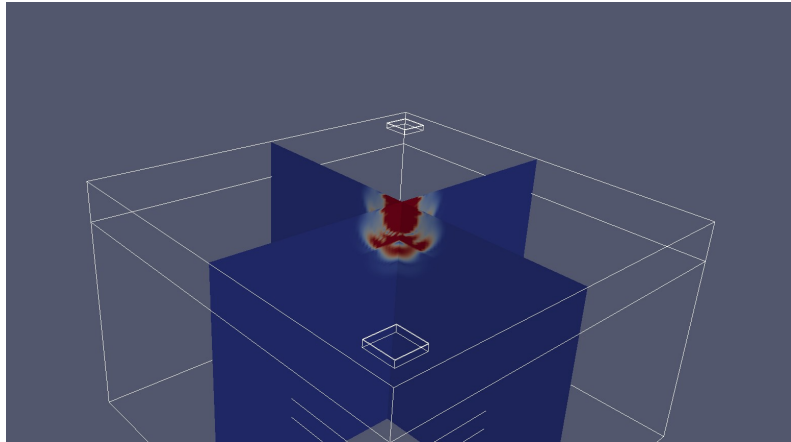

Time 0.15 sec.

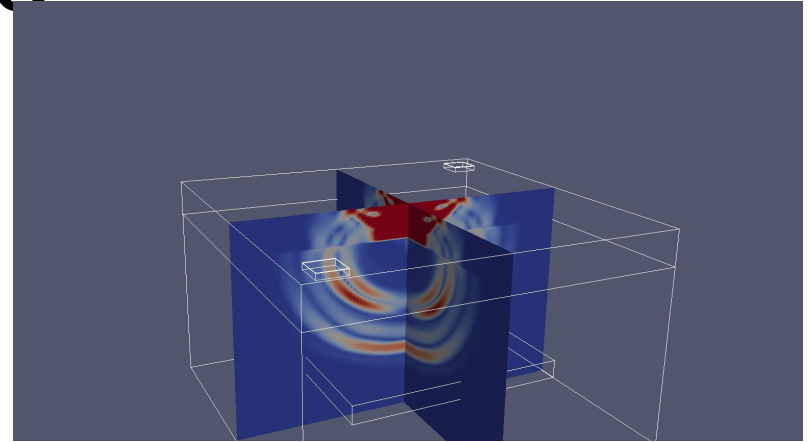

Time 0.35 sec.

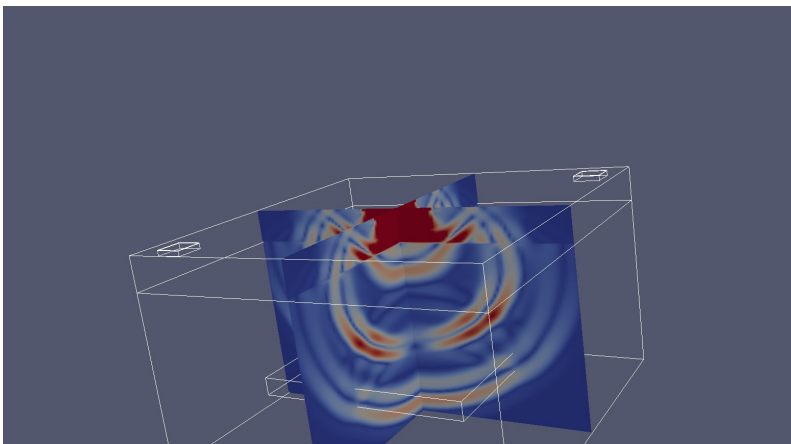

Time 0.45 sec.

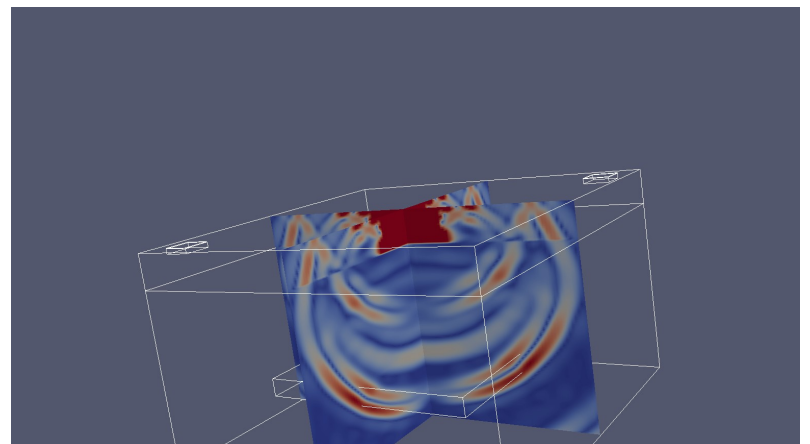

Time 0.6 sec.

Seismograms for models with icebergs

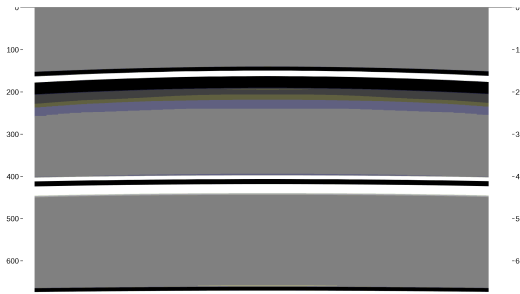

Without oil

1 iceberg

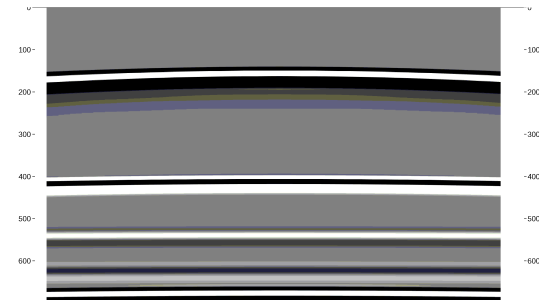

With oil

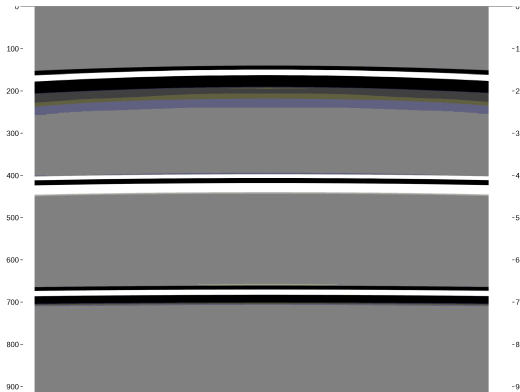

Without oil

2 icebergs

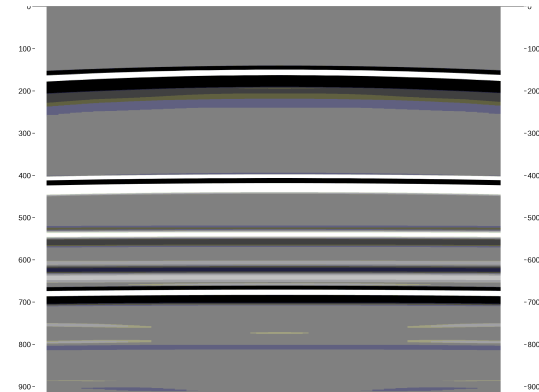

With oil

Models with toros

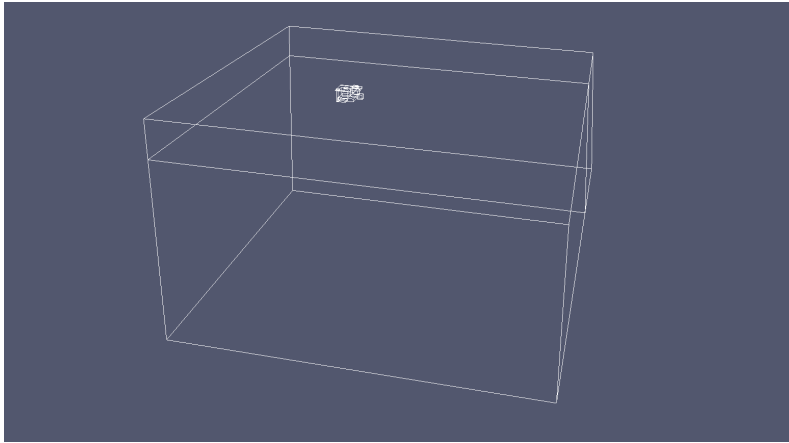

Model with toros without oil

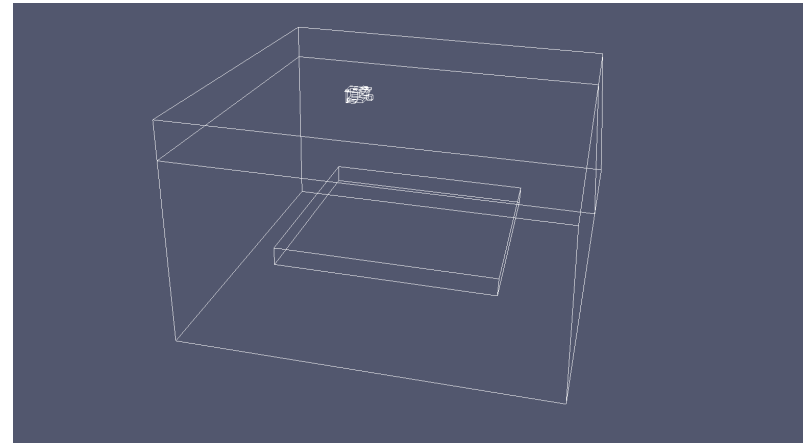

Model with toros with oil

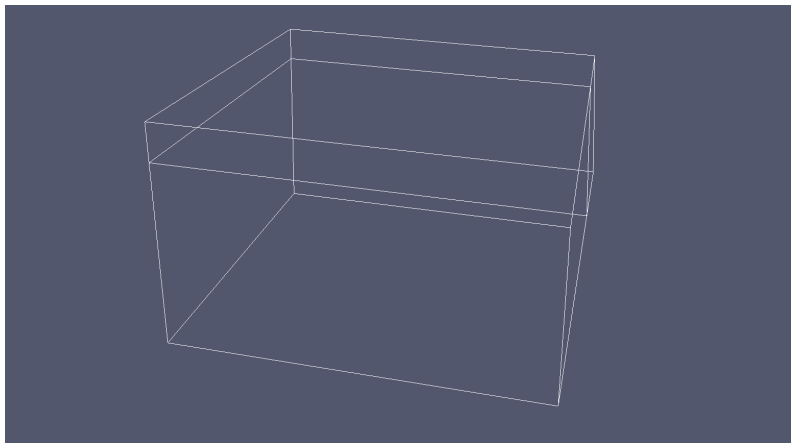

Model without toros and without oil

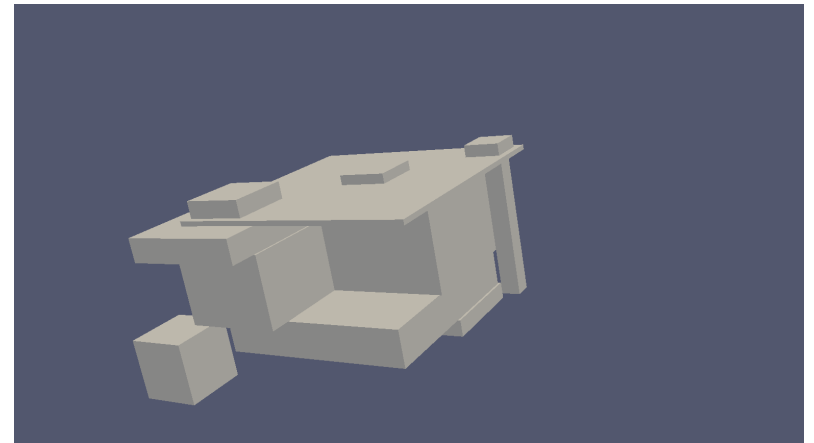

Model of toros

Seismograms for models with toros



Model with toros without oil

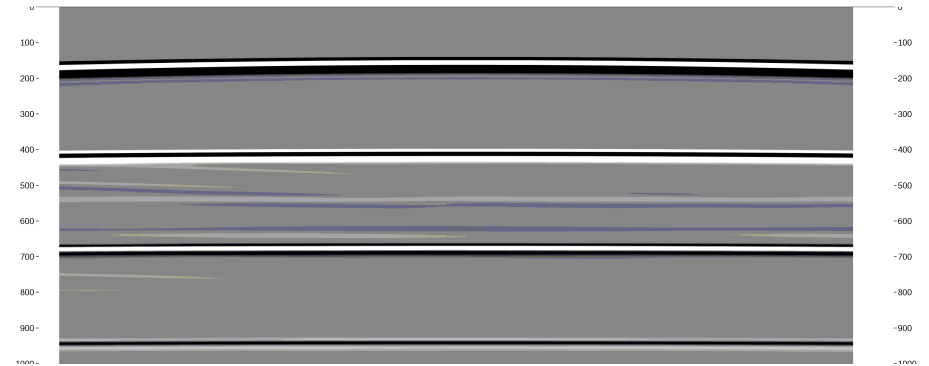

Model with toros with oil



Model without toros and without oil

Conclusions

- Modelling and analysis of seismic replies in seas with (or without) the presence of different ice formations have been conducted
- Appropriate seismograms of replies from the oil slice have been built

Thank you for attention!